

Article number: 01010391  
 Description: Retaining ring A 22 DIN 471  
 Stainless 411  
 Note: Fitted with ZGA pilers

## Measures

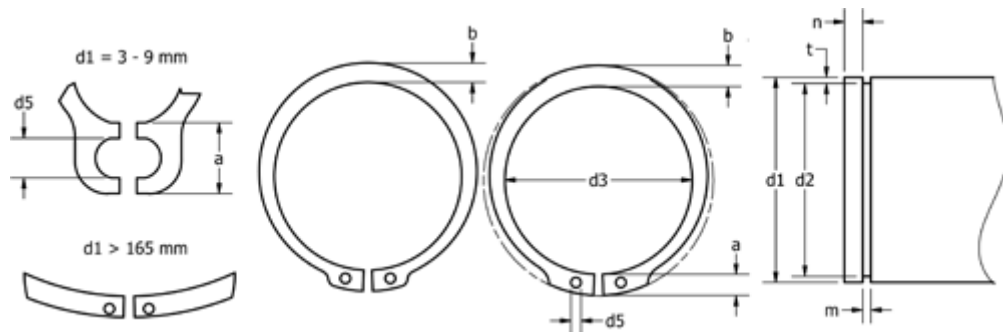

a max	= 4.2	FN kN	= 5.6	s	= 1.20
AN mm <sup>2</sup>	= 33.8	FRg kN	= 3.80	t	= 0.50
b	= 2.8	FR kN	= 16.90	tol	= -0.13
d1	= 22	g	= 1.5	tol	= -0.06
d2	= 21.0	K kN-mm	= 35.40	tol	= +0,13-0,42
d3	= 20.5	m min	= 1.30	Tong	= ZGA-2
d5 min	= 2.0	n abl x 1000	= 27.0	Weight kg/1000	= 1.500
Description	= A22	Nominal drive	= 1.5		